



CX 70 cm

Features:

- # Base station antenna, Mono-band
- # Low-gain, Omnidirectional
- # Factory tunable according to specific customer's frequency (minimum order 100 pcs)
- # Protection from static discharges DC-Ground
- # Made of aluminium alloy 6063 T-832

Specifications

Electrical Data

Type	3/4λ Coaxial J-Pole
Frequency Range at V.S.W.R. ≤ 1.5:1	
CX 410	410-425 MHz
CX 425	425-440 MHz
CX 440	440-455 MHz
CX 455	455-470 MHz
Impedance	50 Ω Unbalanced
Radiation (H-plane)	360° Omnidirectional
Radiation (E-plane)	Beamwidth at -3 dB = 60°
Radiation angle deg.	6°
Polarization	Vertical
Gain	2 dBd - 4.15 dBi
Bandwidth at V.S.W.R. 2:1	
CX 410, CX 425	31 MHz
CX 440, CX 455	33 MHz
V.S.W.R. at res. freq.	≤ 1.2:1
Max Power	200 Watts
Feed System / Position	Gamma Match / Base
Connection	N-Female

Mechanical Data

Materials	Aluminium, Brass, Steel, Nylon
Wind Load / Resistance	25 N at 150 Km/h / 180 Km/h
Wind Surface	0.02 m ²
Height (approx.)	
CX 410	625 mm
CX 425	605 mm
CX 440	590 mm
CX 455	580 mm
Weight (approx.)	450 gr
Mounting Mast	∅ 35-42 mm

- code 2102501.00 CX 410
- code 2102601.00 CX 425
- code 2102701.00 CX 440
- code 2102801.00 CX 455

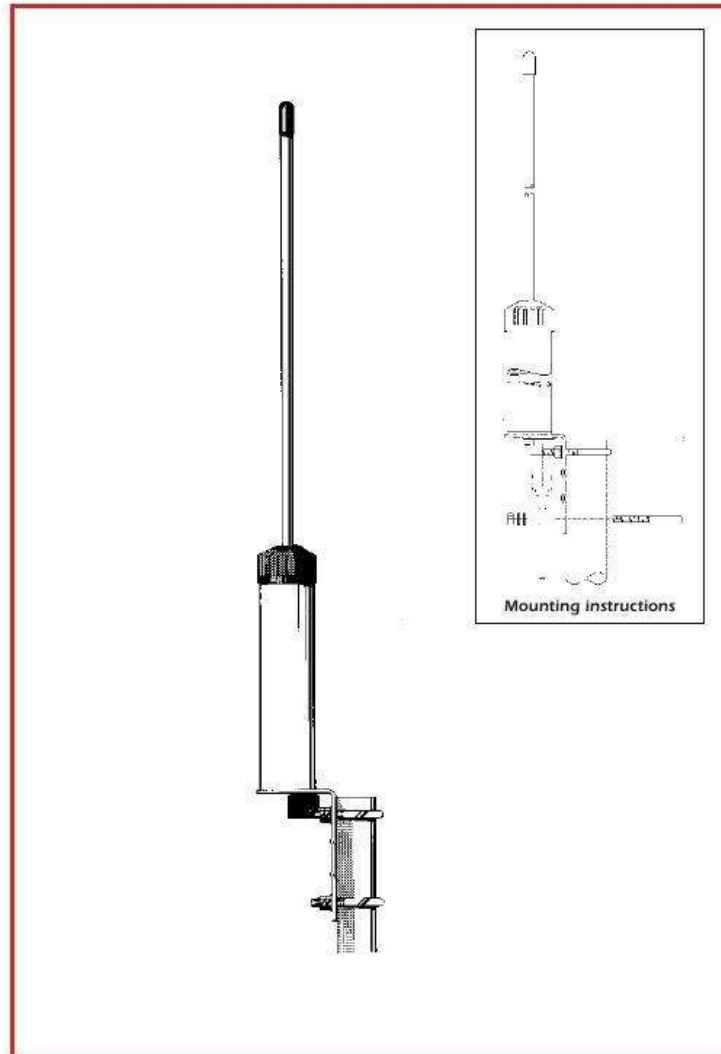

TYPICAL RADIATION PATTERN in E-plane of mid-band
For: CX 402
Scale: linear

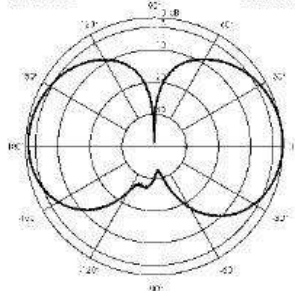

TYPICAL S.W.R. RESPONSE

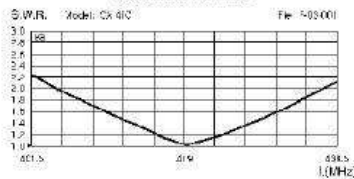

TYPICAL S.W.R. RESPONSE

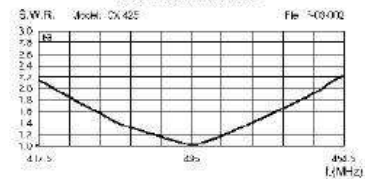

TYPICAL S.W.R. RESPONSE

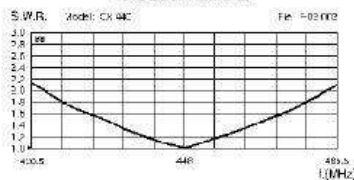

TYPICAL S.W.R. RESPONSE

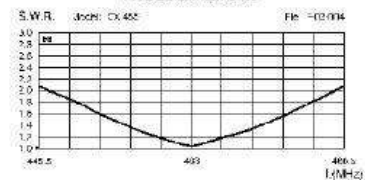

GP 430 LB

UP-GRADED Features:

- # More protection against the worst weather conditions
- # New radials locking system "screw-on"
- # Stainless steel hardware
- # New feeding system design
- # New connectors available: standard "UHF" female with gold plated central pin or "N" female with gold plated central pin and teflon insulator
- # Mounting on mast up to \varnothing 40 mm (old version max \varnothing 38 mm)

Features:

- # Base station antenna, Wide-band
- # Unity-gain, Omnidirectional
- # Protection from static discharges DC-Ground
- # Made of anodized aluminium alloy
- # Side mast mounting allowed by optional bracket FT-2 code 2510004.00 (pag. 59)

Specifications

Electrical Data

Type	1/4 λ Folded Ground Plane
Frequency Range at V.S.W.R. \leq 1.7:1	380-480 MHz
Impedance	50 Ω Unbalanced
Radiation (H-plane)	360° Omnidirectional
Radiation (E-plane)	Beamwidth at -3 dB = 80°
Radiation angle deg.	0°
Polarization	Vertical
Gain	0 dBd - 2.15 dBi
Bandwidth at V.S.W.R. 2:1	140 MHz
V.S.W.R. at res. freq.	\leq 1.2 : 1
Max Power	300 Watts
Feed System / Position	Direct DC-Ground / Center Connection
GP 430 LB/UHF	UHF-Female
GP 430 LB/N	N-Female

Mechanical Data

Materials	Anodized Aluminium, Nylon, Stainless Steel
Wind Load / Resistance	18 N at 150 Km/h / 180 Km/h
Wind Surface	0.02 m ²
Height (approx.)	295 mm
Weight (approx.)	830 gr
Radial Length (approx.)	200 mm
Mounting Mast	\varnothing 36-40 mm

code 2104201.00 GP 430 LB/UHF
code 2104201.00/N GP 430 LB/N

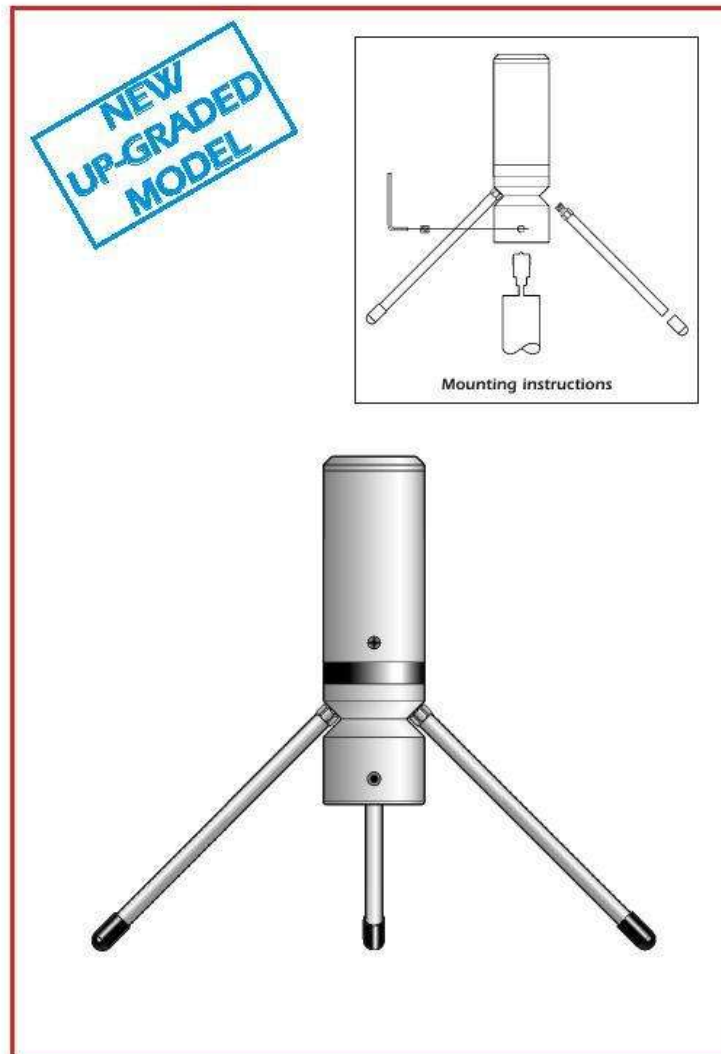

TYPICAL RADIATION PATTERN in E-plane of mid-band

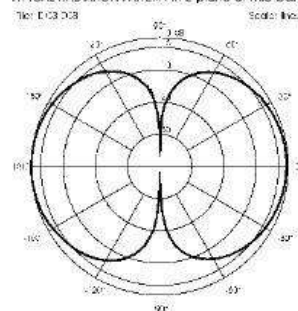

TYPICAL S.W.R. RESPONSE

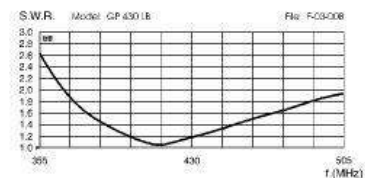

GP 400-470 C

Features:

- # Base station antenna, Omnidirectional
- # Medium-gain, Mono-band
- # Tunable by whip cutting
- # Made of anodized aluminium alloy
- # Stainless steel hardware and radials
- # Equipped with anodized aluminium bracket for an easy side mast installation
- # 17/7 PH stainless steel spring whip
- # Supplied with nylon reinforce part inside the spring whip

Specifications

Electrical Data

Type 1/4λ + 1/2 λ, Colinear
 Frequency Range tunable from 400 to 470 MHz
 Impedance 50 Ω Unbalanced
 Radiation (H-plane) 360° Omnidirectional
 Radiation (E-plane) Beamwidth at -3 dB = 53°
 Radiation angle deg. 0°
 Polarization Vertical
 Gain 2.5 dBd - 4.65 dBi
 Bandwidth at V.S.W.R. 2:1 30 MHz at 400 MHz
 V.S.W.R. at res. freq. ≤ 1.2: 1 at 400 MHz
 Max Power 150 Watts
 Feed System / Position Direct / Base
 Connection N-Female Gold Plated

Mechanical Data

Materials Aluminium, Brass, Stainless Steel 17/7 PH
 Wind Load / Resistance 18 N at 150 Km/h / 180 Km/h
 Wind Surface 0.02 m²
 Height (approx.) 910 mm
 Weight (approx.) 730 gr
 Radial Length (approx.) 200 mm
 Mounting Mast Ø 35-54 mm

code 2102105.00

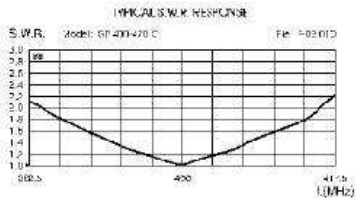

TYPICAL RADIATION PATTERN in E plane at 435 MHz
 Fig. 11 (CS 010)

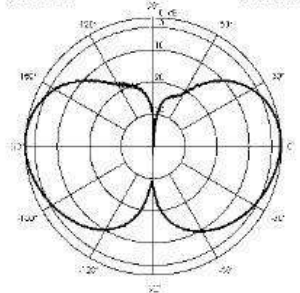

TYPICAL TUNING DIAGRAMS*

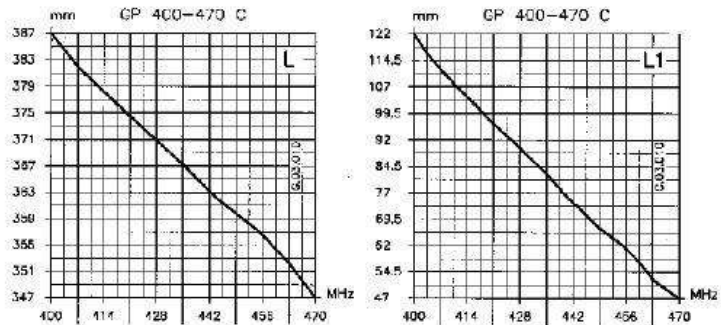

* Diagrams are recommended to be used as a guide and fine tuning by means of SWR-meter

SA 703-N SA 705-N

Features:

- # Base station antenna, Mono-band
- # High-gain, Omnidirectional
- # Factory tunable according to specific customer's frequency (400-470 MHz, minimum order 100 pcs)
- # Protection from static discharges DC-Ground
- # Stainless steel hardware and radials
- # Equipped with anodized aluminium bracket for an easy side mast installation
- # High quality whip made of brass and copper protected by fiberglass tube

Specifications

Electrical Data

Type SA 703-N	3 x 5/8 λ Ground Plane Colinear
SA 705-N	5 x 5/8 λ Ground Plane Colinear
Design frequency	435 MHz
Impedance	50 Ω Unbalanced
Radiation (H-plane)	360° Omnidirectional
Radiation (E-plane) SA 703-N	Beamwidth at -3 dB = 24°
SA 705-N	Beamwidth at -3 dB = 17°
Radiation angle deg. SA 703-N	0°
SA 705-N	-1.5°
Polarization	Vertical
Gain SA 703-N	4.6 dBd - 6.75 dBi
SA 705-N	7.1 dBd - 9.25 dBi
Bandwidth at V.S.W.R. 2:1	16 MHz
V.S.W.R. at res. freq.	≤ 1.2 : 1
Max Power	200 Watts
Feed System / Position	Transformer DC-ground/ Base
Connection	N-Female Gold Plated

Mechanical Data

Materials	Glass Fibre, Aluminium, Stainless Steel, Brass
Wind Load / Resistance		
SA 703-N	56 N at 150 Km/h / 180 Km/h
SA 705-N	81 N at 150 Km/h / 160 Km/h
Wind Surface		
SA 703-N	0.05 m ²
SA 705-N	0.07 m ²
Height (approx.) SA 703-N	1780 mm
SA 705-N	2790 mm
Weight (approx.) SA 703-N	900 gr
SA 705-N	1100 gr
Radial length	170 mm
Mounting Mast	∅ 35-54 mm

code 2106320.00 SA 703-N
code 2106820.00 SA 705-N

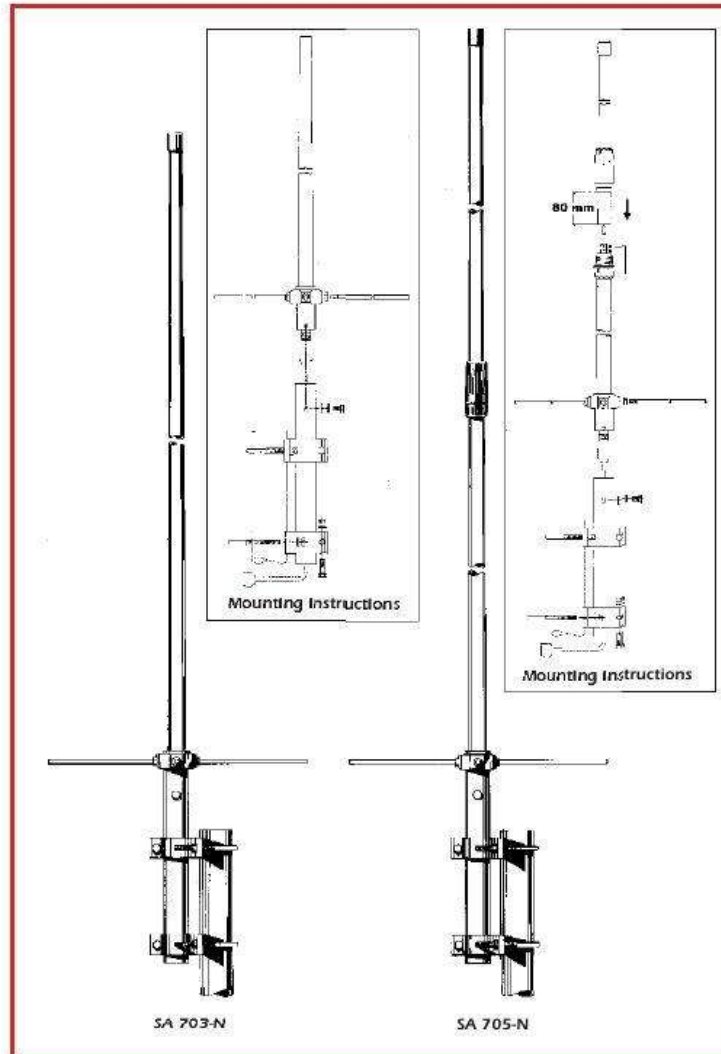

TYPICAL RADIATION PATTERN in E-plane of 435 MHz
Γ_{ref} : 03-005 Scale: linear

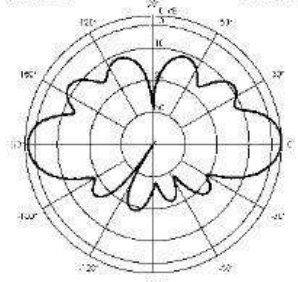

SA 703-N

TYPICAL RADIATION PATTERN in E-plane of 435 MHz
Γ_{ref} : 03-012 Scale: linear

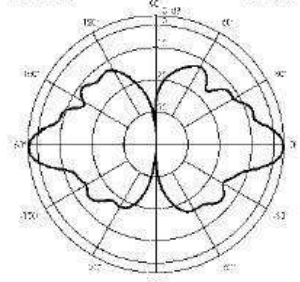

SA 705-N

TYPICAL S.W.R. RESPONSE

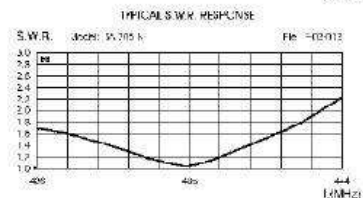
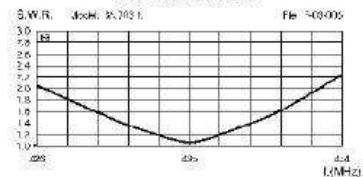

MAG 400 1/4 PL

Features:

- # Suitable for fitting on magnetic mounts, angular connectors, or portable transceiver
- # Unity-gain, Omnidirectional, Mono-band
- # Tunable by whip cutting
- # 17/7 PH stainless steel cylindrical whip
- # Magnetic mount version available

Specifications

Electrical Data

Type 1/4 λ
 Frequency Range tunable from 400 to 470 MHz
 Impedance 50 Ω Unbalanced
 Radiation (H-plane) 360° Omnidirectional
 Polarization Vertical
 Gain 0 dB ref. to $\lambda/4$ whip
 Bandwidth at V.S.W.R. 2:1 40 MHz at 400 MHz
 V.S.W.R. at res. freq. ≤ 1.6 : 1 at 400 MHz
 Max Power 100 Watts
 Feed System / Position Direct / Base
 Connector Type UHF-Male

Mechanical Data

Materials ... Stainless Steel 17/7 PH, Chromed Brass, Nylon
 Height (approx.) 170 mm
 Weight (approx.) 80 gr

code 2431405.05 MAG 400 1/4 PL

MAG 432 PL MAG 400-470 PL

Features:

- # Suitable for fitting on magnetic mounts, angular connectors, or portable transceiver, Mono-band
- # Medium-gain, Omnidirectional
- # MAG 432 PL Factory tuned at 435 MHz
- # MAG 400-470 PL Tunable by whip cutting
- # 17/7 PH stainless steel spring whip
- # Supplied with nylon reinforce part inside the spring whip
- # Magnetic mount version available

Specifications

Electrical Data

Type 1/4 λ + 1/2 λ Colinear
 MAG 432 PL design frequency 435 MHz
 MAG 400-470 PL tunable from 400 to 470 MHz
 Impedance 50 Ω Unbalanced
 Radiation (H-plane) 360° Omnidirectional
 Polarization Vertical
 Gain 3.5 dB ref. to $\lambda/4$ whip
 Bandwidth at V.S.W.R. 2:1
 MAG 432 PL 24.7 MHz
 MAG 400-470 PL 32 MHz at 400 MHz
 V.S.W.R. at res. freq. ≤ 1.2 : 1
 Max Power 100 Watts
 Feed System / Position Direct / Base
 Connector Type UHF-Male

Mechanical Data

Materials ... Stainless Steel 17/7 PH, Chromed Brass, Nylon
 Height (approx.) 800 mm
 Weight (approx.) 150 gr

code 2430305.05 MAG 432 PL
 code 2430405.05 MAG 400-470 PL

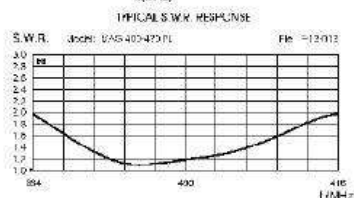
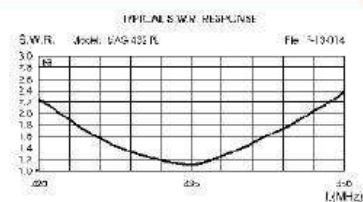
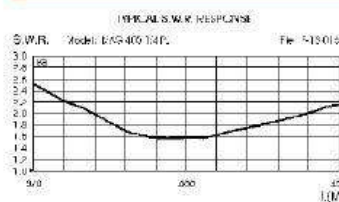
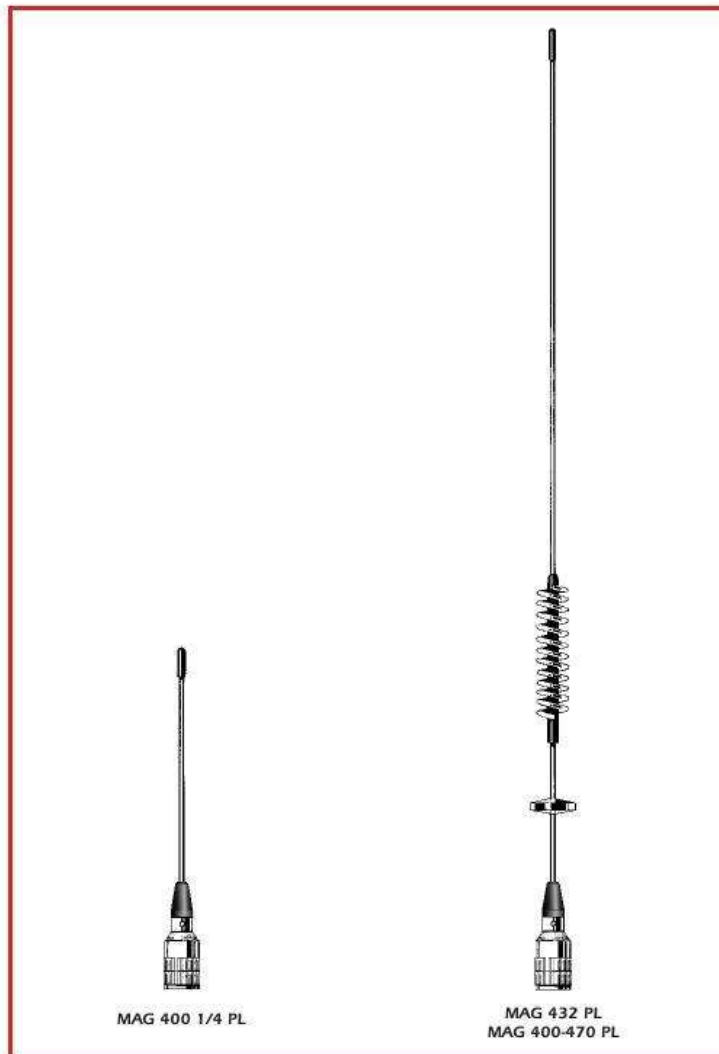

SKA 400-480

Features:

- # Mobile antenna, Mono-band
- # Unity-gain, Omnidirectional
- # Tunable by whip cutting
- # Factory tunable according to specific customer's frequency
- # 17/7 PH stainless steel cylindrical whip
- # 90° inclination and adjustable whip, detachable for car-washes access

Specifications

Electrical Data

Type	1/4λ
Frequency Range	tunable from 400 to 480 MHz
Impedance	50 Ω Unbalanced
Radiation (H-plane)	360° Omnidirectional
Polarization	Vertical
Gain	0 dB ref. to λ/4 whip
Bandwidth at V.S.W.R. 2:1	90 MHz at 400 MHz
V.S.W.R. at res. freq.	≤ 1.2: 1 at 400 MHz
Max Power	100 Watts
Feed System / Position	Direct / Base
Standard Mount	"SL-S"
Cable Length / Type	5 m / RG 58

Mechanical Data

Materials	Stainless Steel 17/7 PH, Chromed Brass, Nylon
Height (approx.)	210 mm
Weight (approx.)	340 gr
Mounting Hole	∅ 19 mm

code 2206806.34 SKA 400-480

SKA 400 1/4

Features:

- # Mobile antenna, Mono-band
- # Unity-gain, Omnidirectional
- # 17/7 PH stainless steel cylindrical whip
- # Rigid whip, detachable for car-washes access
- # Magnetic mount version available
CELL-MAG code 2510202.06

Specifications

Electrical Data

Type	1/4λ
Frequency Range at V.S.W.R. ≤ 1.5:1	415-455 MHz
Impedance	50 Ω Unbalanced
Radiation (H-plane)	360° Omnidirectional
Polarization	Vertical
Gain	0 dB ref. to λ/4 whip
Bandwidth at V.S.W.R. 2:1	85 MHz
V.S.W.R. at res. freq.	≤ 1.2: 1
Max Power	100 Watts
Feed System / Position	Direct / Base
Standard Mount	"ML"
Cable Length / Type	5 m / RG 58

Mechanical Data

Materials	Stainless Steel 17/7 PH, Chromed Brass, Nylon
Height (approx.)	180 mm
Weight (approx.)	260 gr
Mounting Hole	∅ 14 or 18 mm

code 2206906.48 SKA 400 1/4

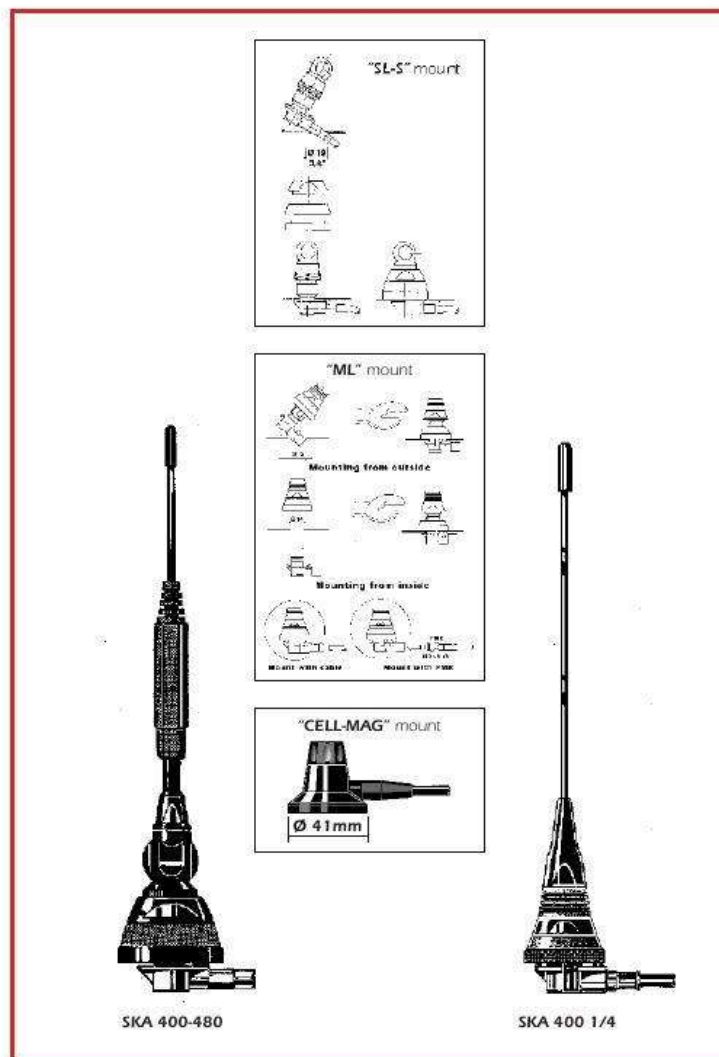

TYPICAL S.W.R. RESPONSE Model: SKA 400-480 FR: 513-015

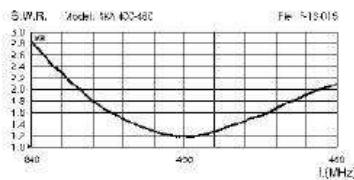

TYPICAL S.W.R. RESPONSE Model: SKA 400 1/4 FR: 513-005

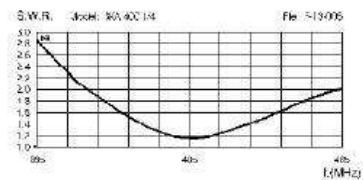

SU 3 5/8

Features:

- # Mobile antenna, Mono-band
- # Low-gain, Omnidirectional
- # Tunable by whip cutting
- # Factory tunable according to specific customer's frequency
- # 17/7 PH stainless steel spring whip
- # SL mount version 180° inclination and adjustable whip, detachable for car-washes access
- # SL-S mount version 90° inclination and adjustable whip, detachable for car-washes access
- # Magnetic mount version available

Specifications

Electrical Data

Type	5/8 λ
Frequency Range	tunable from 400 to 470 MHz
Impedance	50 Ω Unbalanced
Radiation (H-plane)	360° Omnidirectional
Polarization	Vertical
Gain	2 dB ref. to λ/4 whip
Bandwidth at V.S.W.R. 2:1	20 MHz at 400 MHz
V.S.W.R. at res. freq.	≤ 1.3: 1 at 400 MHz
Max Power	100 Watts
Feed System / Position	Transformer / Base
Standard Mount	"SL"
Cable Length / Type	5 m / RG 58

Mechanical Data

Materials	Stainless Steel 17/7 PH, Chromed Brass, Nylon
Height (approx.)	525 mm
Weight (approx.)	360 gr
Mounting Hole	∅ 19 mm

code 2205406.33 SU 3 5/8 black SL mount
code 2205406.34 SU 3 5/8 black SL-S mount

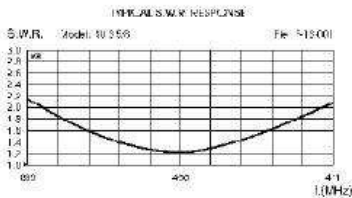
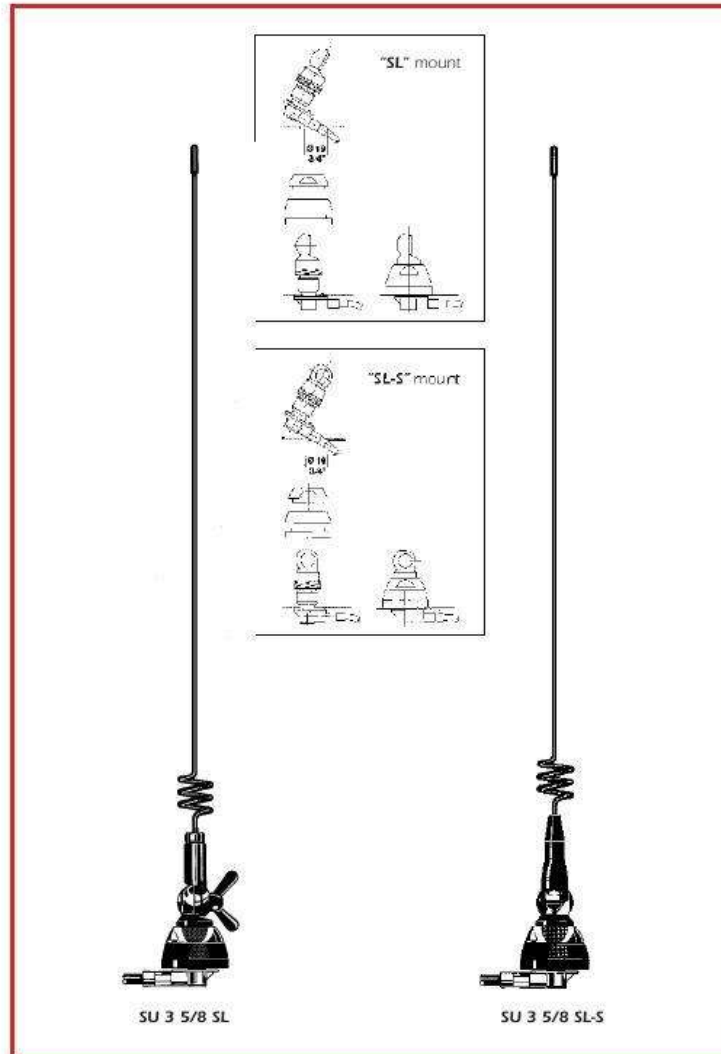

TYPICAL TUNING DIAGRAMS*

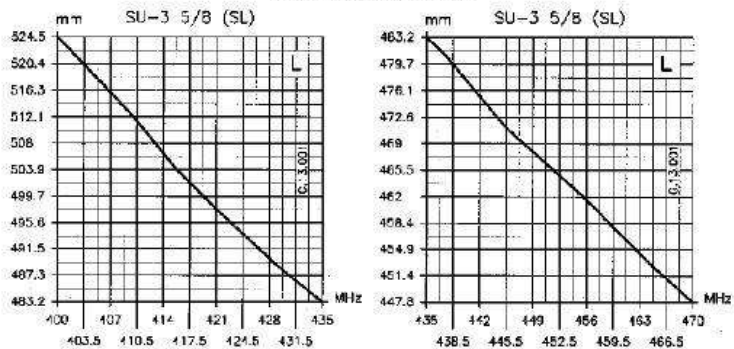

* Diagrams are recommended to be used as a guide and fine tuning by means of SWR-meter

SU 4-5-6-7

Features:

- # Mobile antenna, Mono-band
- # Medium-gain, Omnidirectional
- # Fine tuning by disk adjusting
- # 17/7 PH stainless steel spring whip
- # Supplied with nylon reinforce part inside the spring whip
- # SL mount version 180° inclination and adjustable whip, detachable for car-washes access
- # SL-S mount version 90° inclination and adjustable whip, detachable for car-washes access
- # Black chrome version available
- # Wide range of optional mounting bases available
- # Magnetic mount version available

Specifications

Electrical Data

Type	1/4λ + 1/2 λ, Colinear
Frequency Range at V.S.W.R. ≤ 1.5:1	
SU 4	405-430 MHz
SU 5	425-450 MHz
SU 6	445-470 MHz
SU 7	465-490 MHz
Impedance	50 Ω Unbalanced
Radiation (H-plane)	360° Omnidirectional
Polarization	Vertical
Gain	3.5 dB ref. to λ/4 whip
Bandwidth at V.S.W.R. 2:1	
SU 4	52 MHz at 418 MHz
SU 5	54 MHz at 438 MHz
SU 6	56 MHz at 458 MHz
SU 7	58 MHz at 458 MHz
V.S.W.R. at res. freq.	≤ 1.2:1
Max Power	100 Watts
Feed System / Position	Direct / Base
Standard Mount	"SL"
Cable Length / Type	5 m / RG 58

Mechanical Data

Materials	Stainless Steel 17/7 PH, Chromed Brass, Nylon
Height (approx.)	
SU 4	620 mm
SU 5	585 mm
SU 6	555 mm
SU 7	510 mm
Weight (approx.)	420 gr
Mounting Hole	∅ 19 mm

code 2205505.32	SU 4 chrome SL mount
code 2205506.33	SU 4 black SL mount
code 2205506.34	SU 4 black SL-S mount
code 2205605.32	SU 5 chrome SL mount
code 2205606.33	SU 5 black SL mount
code 2205606.34	SU 5 black SL-S mount
code 2205705.32	SU 6 chrome SL mount
code 2205706.33	SU 6 black SL mount
code 2205706.34	SU 6 black SL-S mount
code 2206005.32	SU 7 chrome SL mount
code 2206006.33	SU 7 black SL mount
code 2206006.34	SU 7 black SL-S mount

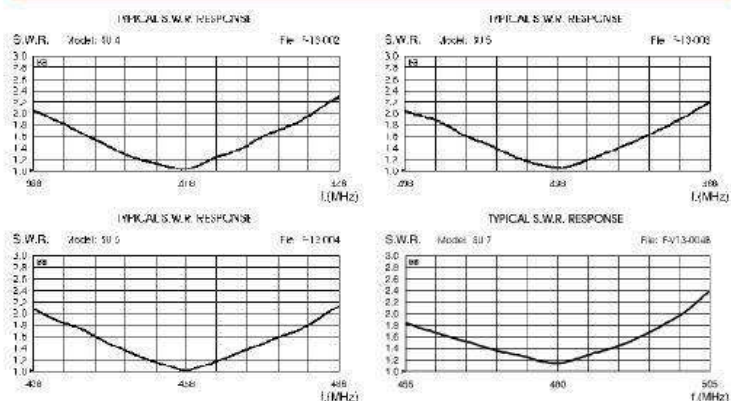
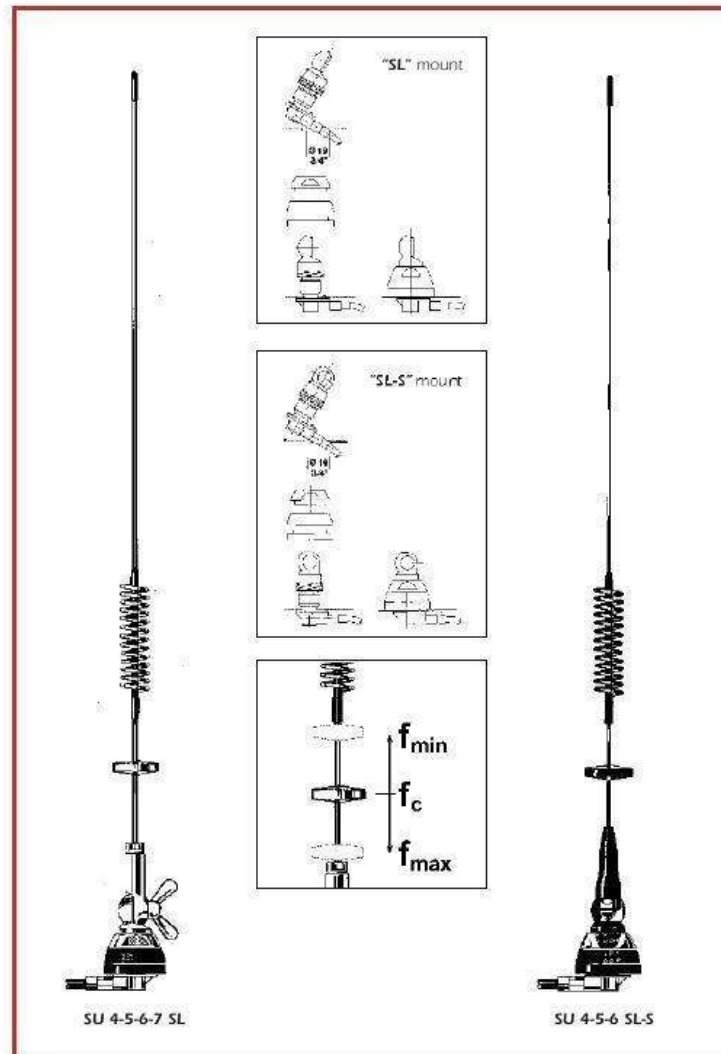

HP 7000 HP 7000 C

Features:

- # Mobile antenna, Mono-band
- # Omnidirectional
- # HP 7000 Low-gain,
HP 7000 C High-gain
- # Protection from static discharges
DC-Ground
- # 17/7 PH stainless steel cylindrical whip
- # 90° tiltable whip and detachable for
car-washes access
- # Wide range of optional mounting bases
available
- # Magnetic mount version available

Specifications

Electrical Data

Type	
HP 7000	5/8 λ
HP 7000 C	2 x 5/8 λ, Colinear
Design Frequency	435 MHz
Impedance	50 Ω Unbalanced
Radiation (H-plane)	360° Omnidirectional
Polarization	Vertical
Gain	
HP 7000	2 dB ref. to λ/4 whip
HP 7000 C	5 dB ref. to λ/4 whip
Bandwidth at V.S.W.R. 2:1	
HP 7000	18 MHz
HP 7000 C	14 MHz
V.S.W.R. at res. freq.	≤ 1.2: 1
Max Power	100 Watts
Feed System / Position	Transformer DC-ground / Base
Connector Type	UHF-Male

Mechanical Data

Materials	Stainless Steel 17/7 PH, Chromed Brass, Nylon
Height (approx.)	
HP 7000	435 mm
HP 7000 C	1000 mm
Weight (approx.)	
HP 7000	250 gr
HP 7000 C	320 gr

code 2210505.05 HP 7000
code 2210605.05 HP 7000 C

Both models available for USA ham band
(445 MHz)

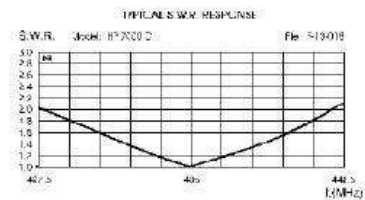
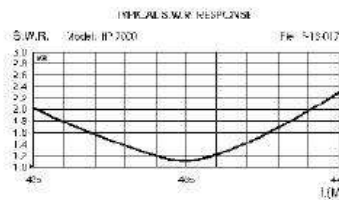
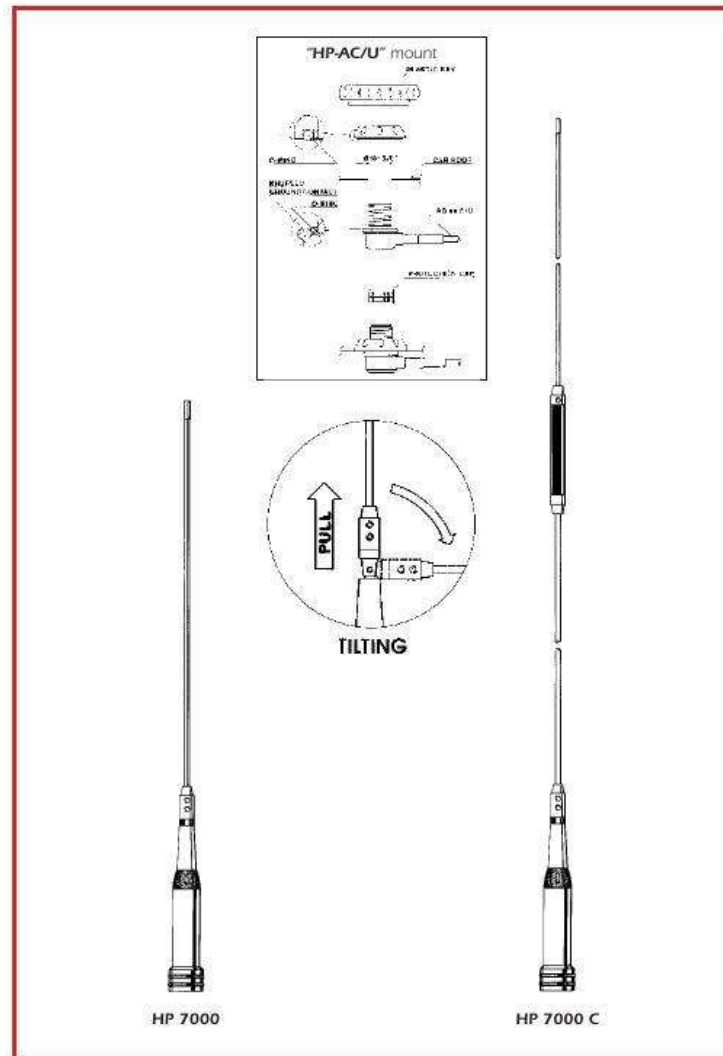



"S" Mount Type
 Frequency Range: from DC to 300 MHz
 Overall Size: \varnothing 42 mm
 Mounting Hole: \varnothing 19 mm
 "S" Chrome 2501102.01
 "S" Black 2501102.02



"SL" Mount Type
 Frequency Range: from DC to 500 MHz
 Overall Size: \varnothing 39 mm
 Mounting Hole: \varnothing 19 mm
 "SL" Chrome 2501102.01
 "SL" Black 2501102.02



"SL-S" Mount Type
 Frequency Range: from DC to 500 MHz
 Overall Size: \varnothing 39 mm
 Mounting Hole: \varnothing 19 mm
 "SL-S" Black 2501102.04



"ML" Mount Type
 Frequency Range: from DC to 1000 MHz
 Overall Size: \varnothing 30mm
 Mounting Hole: \varnothing 14 or 18 mm
 "ML" 2501202.06



"ABN" Trunk Mount
 Fixing Hole: \varnothing 16 mm
 Material: Painted Steel
 ABN Black 2504105.00



"TRUNK TOP 2" Mount
 DV/PL Chrome 2504406.12
 DV/PL Black 2504407.13
 PL-3/8 Chrome 2504406.14
 PL-3/8 Black 2504407.14



"KF" Gutter Mount
 Fixing Hole: \varnothing 16 mm
 Material: Painted Zinc
 KF Black 2504205.00
 KF Black 3/8 + PL + Cable 2504205.03



"Screw & Bolt"
 Materials: Brass and Zinc, Chrome plated
 Chrome 2506206.00
 Black 2506207.00



"Wing Bolt"
 Materials: Brass, Chrome plated
 Chrome 2506306.00
 Black 2506307.00

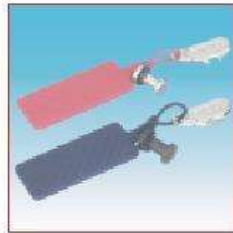

"Safety Set"
 Materials: Brass and Zinc, Chrome plated
 Chrome 2506506.00
 Black 2506507.00



"FT-2" Fixing Bracket
 Top Size: \varnothing 38 mm for antenna fitting
 Bottom Size: \varnothing 45/50 mm for fitting on the mast
 Weight (approx.): 1100 gr
 Material: Galvanized Steel
 FT-2 Universal 2510004.00



"FT-3" Fixing Bracket
 Top Size: \varnothing 30 mm for antenna fitting
 Bottom Size: \varnothing 35/54mm for fitting on the mast
 Weight (approx.): 350 gr
 Material: Anodized aluminium, Stainless steel
 FT-3 2511301.00



"M-1" Marine Bracket
 Dimension L x W x H : 38 x 64 x 98 mm
 Weight (approx.): 120 gr
 Material: Stainless Steel
 M-1 Marine Bracket 2503503.00



"M-3" Marine Mount
 Connection: standard 1"x14 threads
 Dimension L x W x H : 60 x 95 x 130 mm
 Weight (approx.): 840 gr
 Materials: Chromed Brass, Stainless steel hardware
 M-3 OT Marine Mount 2503606.00



"M-8" Marine Mount
 Connection: standard 1"x14 threads
 Dimension L x W x H : 70 x 105 x 130 mm
 Weight (approx.): 250 gr
 Materials: Nylon, Stainless steel hardware
 M-8 NY Marine Mount 2503301.00



"M-10" Marine Mount
 Connection: standard 1"x14 threads
 Fixing diameter: 1"
 Weight (approx.): 600 gr
 Materials: Chromed Brass, Stainless steel hardware
 M-10 OT Marine Mount 2503406.00



"MAG H 12" Magnet Mount

MAG H 12 PL	2502502.05
MAG H 12 S	2502502.01
MAG H 12 S Black	2502502.02
MAG H 12 3/8	2502502.03



"MAG 125" Magnet Mount

MAG 125 PL	2502602.05
MAG 125 S	2502602.01
MAG 125 S Black	2502602.02
MAG 125 3/8	2502602.03



"MAG 145" Magnet Mount

MAG 145 PL	2502702.05
MAG 145 S	2502702.01
MAG 145 S Black	2502702.02
MAG 145 3/8	2502702.03



"MAG 160" Magnet Mount

MAG 160 PL	2502802.05
MAG 160 S	2502802.01
MAG 160 S Black	2502802.02
MAG 160 3/8	2502802.03



"HP MAG H 12 PL" Magnet Mount

Frequency Range: from DC to 500 MHz
Materials: Nylon, Chromed brass, Teflon insulator,
Gold plated pin, 3.6m RG58 C/U MILC17
HP MAG H 12 PL 2511802.05



"HP MAG 125 PL" Magnet Mount

Frequency Range: from DC to 500 MHz
Materials: Nylon, Chromed brass, Teflon insulator,
Gold plated pin, 3.6m RG58 C/U MILC17
HP MAG 125 PL 2511202.05



"HP-AC/U" Angular Connector

Frequency Range: from DC to 500 MHz
Materials: Brass nichel plated, Teflon insulator,
Gold plated pin, 5m RG58 C/U MIL C17
HP-AC/U + Cable 2510805.00

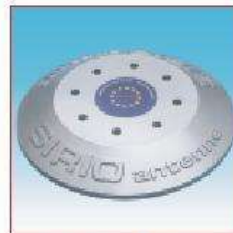

"Antennas Display"

Materials: Painted Zinc with rubber gasket
Fixing Hole: 8 x Ø 12.5 mm
DISPLAY 2508008.00



Wall Antennas Dispenser

Dimension L x H : 140 x 190 mm
Materials: Aluminium, Painted steel
Wall antennas dispenser 32.0002



SMA-male

Crimp type for RG 58, CO 100 30.SMA001.00
Crimp type for RG 174, RG 316 30.SMA002.00



SMA-female

Crimp type for RG 58, CO 100 30.SMA003.00
Crimp type for RG 174, RG 316 30.SMA004.00



BNC-male

Crimp type for RG 58, CO 100 30.BNCO01.00



TNC-male

Crimp type for RG 58, CO 100 30.TNCO01.00



N-male

Crimp type for RG 58, CO 100 30.N001.00



N-female

Crimp type for RG 58, CO 100 30.N002.00



FME-male

Crimp type for RG 58, CO 100 30.FME001.00
Crimp type for RG 174, RG 316 30.FME005.00



FME-female

Crimp type for RG 58, CO 100 30.FME002.00
Crimp type for RG 174, RG 316 30.FME003.00



FME-m / UHF-m adaptor

Code 30.AD002.00



FME-m / Mini UHF-m adaptor

Code 30.AD004.00



FME-m / BNC-m adaptor

Code 30.AD005.00



FME-m / N-m adaptor

Code 30.AD006.00

COAXIAL CABLES Data

Type	Impedance	External diameter	Color
RG 58 C/U	50 Ω	4.95 mm	Black
CO 100	50 Ω	4.95 mm	White
RG 174	50 Ω	2.8 mm	Black
RG 316/U	50 Ω	2.5 mm	Brown

Attenuation dB for 100 m

Freq. Cable	25 MHz	50 MHz	100 MHz	200 MHz	300 MHz	400 MHz	500 MHz	800 MHz	1 GHz	1.6 GHz	1.8 GHz	2.0 GHz	2.2 GHz	2.4 GHz	2.5 GHz	3.0 GHz
RG 58 C/U	7	10	15	21	26	30	34	44	50	66	70	76	78	86	87	98
CO 100	5	7	10	14	17	20	23	29	33	42	45	48	50	53	54	60
RG 174	13	18	27	39	48	56	64	84	95	124	133	141	150	159	162	184
RG 316/U	12	17	26	38	47	55	62	80	91	118	126	134	141	149	152	169